

## EXPERIMENTAL VERIFICATION OF MODAL PARAMETERS FOR 3-LAYERED SANDWICH BEAMS†

M. LEIBOWITZ and J. M. LIFSHITZ

Faculty of Mechanical Engineering, Technion—Israel Institute of Technology,  
Technion City, Haifa 32000, Israel

(Received 7 November 1988)

**Abstract**—Three-layer sandwich beams, made of two elastic outer layers and a viscoelastic layer sandwiched between them, are considered as damping structural elements. The natural frequencies and damping of the beams are determined experimentally for the two low modes, using a GEN-RAD 2507 computer. The results are compared to predicted values based on a numerical solution of a sixth-order equation of motion with complex coefficients. The numerical solution is used to show the effects of some parameters (the thickness of the layers) on damping of the sandwich beam.

### INTRODUCTION

In a previous paper (Lifshitz and Leibowitz, 1987), a method was developed for the optimal design of three-layer sandwich beams made of two elastic layers and a viscoelastic layer sandwiched between them. A sixth-order equation of motion with complex coefficients, of a sandwich beam in free vibrations, was solved numerically and the solution was used later as part of an optimal design program. An experimental program was initiated to verify the predicted values of the damping and the natural frequencies of the beam. An account of the experimental program and the comparison to the predicted values are the main issue of this paper. In addition, the effects of some parameters (e.g. the thickness of the viscoelastic layer) on the damping of the sandwich beam are discussed.

The next sections describe the sandwich beams; the method of measuring the viscoelastic properties of the core material; the experimental set-up for measuring the modal parameters of the beams, and a brief description of the method of calculating the modal parameters. This is followed by a comparison between the measured and predicted values and finally, the effects of varying the thickness of the layers on the modal parameters are discussed.

### EXPERIMENTAL

The beams were made by molding a layer of Neoprene CR-602 between two layers of 2024 aluminum. Forty millimeters along the center of the beam (see Fig. 1), the Neoprene core was replaced by aluminum, to facilitate gripping of the beam to a heavy stationary base. Thus each unit contained two fixed-free cantilever beams of length 180 mm each. The dimensions of the beams in the program are listed in Table 1.

The Neoprene that was used in the program was processed from a single batch to minimize variations in properties. Its dynamic shear modulus  $G_2$ , and damping  $\eta_2$ , were determined experimentally over a frequency range of 100–700 Hz. Figure 2 shows the test arrangement for measuring these properties using a method of forced vibrations, as implemented by Jones and Parin (1972) and by Smith *et al.* (1983).

The test arrangement for measuring the modal parameters of the sandwich beams is shown in Fig. 3. The sandwich beam was attached rigidly to a heavy base that rested on a rubber pad. An impact by a PCB-modally tuned impulse hammer, instrumented with a piezoelectric force transducer, excited the vibratory motion of the sandwich beam. The

† This work is part of an M.Sc. Thesis of the first author, undertaken at Technion—Israel Institute of Technology.

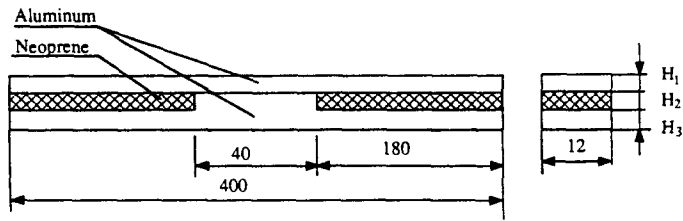

Fig. 1. Geometry of a sandwich beam (dimensions in millimeters).

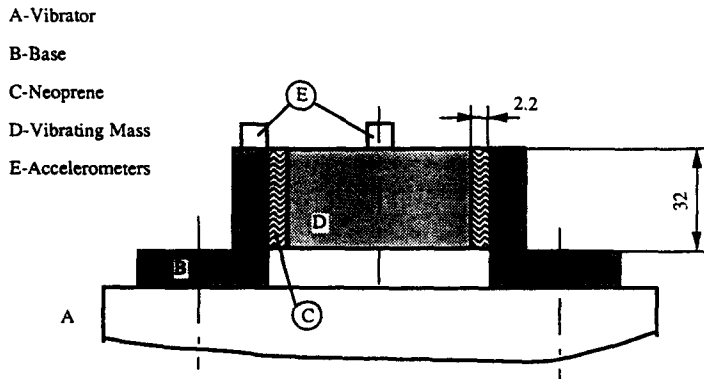

Fig. 2. Test arrangement for measuring Neoprene's dynamic properties (dimensions in millimeters).

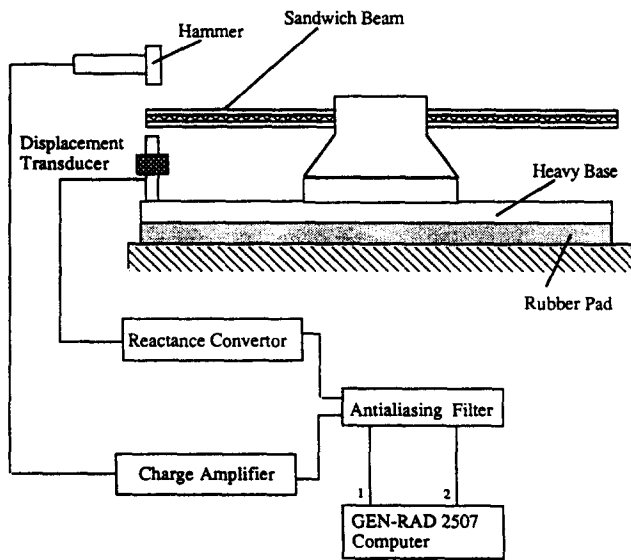

Fig. 3. Test arrangement for sandwich beams.

Table 1. Specimens geometry

Beam	$H_1$ (mm)	$H_2$ (mm)	$H_3$ (mm)
1A	1.1	0.7	4.5
2A	2.0	0.8	5.5
4A	3.7	1.2	3.7
7A	5.0	2.7	1.0
10A	5.0	3.0	2.0
11A	4.0	1.7	4.0

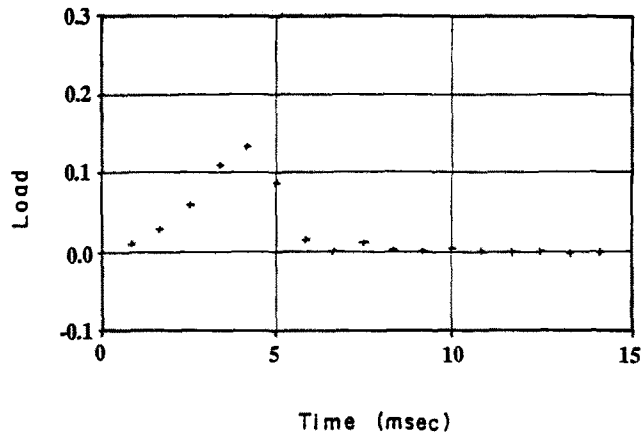

Fig. 4. A typical impulse sampling of a sandwich beam.

damped motion was picked up by a proximity displacement transducer which was attached to the heavy base near the free edge of the beam. The force and displacement signals were fed into a GEN-RAD 2507 computer for further processing and calculation of the modal parameters.

Details of the experimental conditions and instructions how to run the tests are given in the manual of CAE International (1983), and by Ramsey (1975, 1976), and Ewin (1984). However, since the procedure is fairly complex and requires many decisions by the operator of the instruments, some guidelines are given here.

- The amplitude and duration of the exciting pulse must be in the right range, so that the required mode of vibration is excited without causing overload. This can be controlled by selecting different caps for the impact head.
- The working frequency, which determines the rate of sampling the exciting impulse, must be high enough to allow at least five sampling points and at the same time low enough to prevent high bias error. A typical impulse sampling is shown in Fig. 4.
- The number of impulsive excitations in each test must be quite high (we used 20), to assure high coherency.
- The initial gap between the beam and the displacement transducer should be determined such that its output signal be as close to linear as possible over the entire range of the vibratory motion.

The frequency response of the sandwich beam was approximated by an analytical function based on the energy spectral density of Prony (Hildebrand, 1956; Van Blancum, 1978). The damped frequency and the damping ratio were two of the parameters that were obtained by this procedure. The values that were obtained by the curve fitting process depended on the visual judgement of the operator and his selection of various parameters, but with some training and care (Formenti and Welaratna, 1981), variations in values obtained from different "acceptable" functions were about 3% in frequency (of the first mode) and not more than 15% in damping.

#### CALCULATION OF MODAL PARAMETERS

The analytic prediction of the modal parameters consisted of two parts :

- (a) developing the equation of motion and the proper boundary conditions, and
- (b) solving the problem numerically.

The equation of motion for transverse vibrations and the solution type, followed the derivation given by Mead and Markus (1969). The numerical solution was based on the procedure developed by Rao (1977), by using an improved iteration procedure with complex

double precision. Some of the derivations and the assumptions are repeated here for completeness.

A sandwich beam is made of three layers: two elastic face plates with thickness  $H_1$  and  $H_3$  and moduli  $E_1$  and  $E_3$ , respectively, and a viscoelastic core of thickness  $H_2$ , density  $\rho_2$ , and complex shear modulus  $G = G_2(1 + i\eta_2)$ . The width of the beam is  $b$ , and its length  $L$ . The following assumptions are used in developing the equation of motion:

- (a) the elastic face-plates carry only longitudinal stresses;
- (b) the core carries only shear stresses and is modelled as a linear viscoelastic material;
- (c) transverse strains are neglected in both core and face-plates;
- (d) the layers are perfectly bonded;
- (e) the longitudinal and rotatory inertia are neglected.

The equation of motion for free transverse displacement  $w(x, t)$  is

$$\frac{\partial^6 w}{\partial \bar{x}^6} - g(1 + Y) \frac{\partial^4 w}{\partial \bar{x}^4} + \frac{\partial^4 w}{\partial \bar{x}^2 \partial \bar{t}^2} - g \frac{\partial^2 w}{\partial \bar{t}^2} = 0 \quad (1)$$

where  $\bar{x}$  and  $\bar{t}$  are normalized length and time:

$$\bar{x} = x/L \quad \text{and} \quad \bar{t} = t/t_0; \quad [t_0 = (mL^4/D_t)^{1/2}], \quad (2)$$

$m$  is the mass of the beam per unit length and  $D_t$  is the total flexural rigidity:

$$D_t = b(E_1 H_1^3 + E_3 H_3^3)/12, \quad (3)$$

$g$  is a shear parameter:

$$g = G_2(1 + i\eta_2)L^2 b(E_1 A_1 + E_3 A_3)/(H_2 E_1 A_1 E_3 A_3), \quad (4)$$

and  $Y$  is a geometric parameter:

$$Y = (d^2/D_t)E_1 A_1 E_3 A_3/(E_1 A_1 + E_3 A_3) \quad (5)$$

where  $d = H_2 + (H_1 + H_3)/2$ .

The modal parameters are obtained by considering a solution

$$w(\bar{x}, \bar{t}) = W_n(\bar{x})T(\bar{t}) \quad (6)$$

that leads to the two equations

$$\ddot{T} + \bar{\omega}_n^2(1 + i\eta_n)T = 0 \quad (7)$$

and

$$W_n^{VI} - g(1 + Y)W_n^{IV} - \bar{\omega}_n^2(1 + i\eta_n)(W_n^{II} - gW_n) = 0. \quad (8)$$

The (normalized) natural frequencies,  $\bar{\omega}_n$ , and modal damping,  $\eta_n$ , are obtained by solving eqn (8) subject to the appropriate boundary conditions. These conditions for the clamped-free case used in our work are

$$W = W^I = W^V - gYW^{III} = 0 \quad (9)$$

for the clamped end, and

Table 2. Experimental and theoretical modal parameters of fixed-free sandwich beam in mode 1

Beam	Frequency (Hz)			Damping, $\eta$		
	Measured	Calculated	% Deviation	Measured	Calculated	% Deviation
1A	115.5	113.2	-2.0	0.052	0.0527	1.3
2A	139.5	133.9	-4.0	0.062	0.0598	-3.5
4A	107.5	105.4	-2.0	0.072	0.0816	13.3
7A	120.5	124.4	3.2	0.054	0.0506	-6.3
10A	115.0	119.2	3.7	0.060	0.0598	-0.3
11A	115.5	111.7	-3.3	0.078	0.0733	-6.0

$$\left. \begin{aligned} W^{II} &= 0 \\ W^{IV} - \bar{\omega}_n^2(1 + i\eta_n)W &= 0 \\ W^V - g(1 + Y)W^{III} - \bar{\omega}_n^2(1 + i\eta_n)W^I &= 0 \end{aligned} \right\} \quad (10)$$

for the free end. The calculated values of natural frequencies and damping in the next section were obtained by a numerical solution of the determinant derived from the boundary conditions, using an improved iteration procedure with complex double precision.

RESULTS AND DISCUSSION

The dynamic properties of the viscoelastic core were determined by the tests to have a linear frequency dependence in the test range. The dynamic shear modulus  $G_2$  and damping  $\eta_2$  are given by

$$\begin{aligned} G_2(f) &= 1.007 \times 10^{-3} f + 1.386 \text{ MPa} \\ \eta_2(f) &= 1.608 \times 10^{-4} f + 0.256 \end{aligned}$$

where  $f$  is the frequency in Hertz.

These values, together with Young's modulus  $E = 71$  GPa for the aluminum skins, were used in the numerical procedure of Lifshitz and Leibowitz (1987) to calculate the damped natural frequency and damping of the sandwich beams listed in Table 1, for the fixed-free end conditions. The results of the calculations and the experiments are listed in Table 2 for the first mode and in Table 3 for the second.

It is clear from the tables that the agreement between the experimental and calculated frequencies is good for the first mode and reasonable for the second mode. The agreement between damping values is less favorable: all but one of the beams show variation of up to 6% in the first mode, and up to 33% in the second. This may sound a lot, but in fact damping measurements are known to have large variations, which become larger for higher modes even when the excitation is sinusoidal. In the present work, where the beam is excited impulsively and the "experimental" values are obtained after some curve fitting and other approximations by the operator of the system, it is not surprising that we get such variations. Hence, the values in Tables 2 and 3 are within the range of acceptable results, and the

Table 3. Experimental and theoretical modal parameters of fixed-free sandwich beam in mode 2

Beam	Frequency (Hz)			Damping, $\eta$		
	Measured	Calculated	% Deviation	Measured	Calculated	% Deviation
1A	628.5	669.0	6.4	0.041	0.0310	-24.4
2A	765.0	793.0	3.7	0.049	0.0330	-32.7
4A	581.0	613.0	5.5	0.035	0.0402	14.9
7A	674.0	747.0	10.8	0.036	0.0235	-34.7
10A	631.0	712.0	12.8	0.036	0.0270	-25.0
11A	612.0	658.0	7.5	0.049	0.0344	-29.8

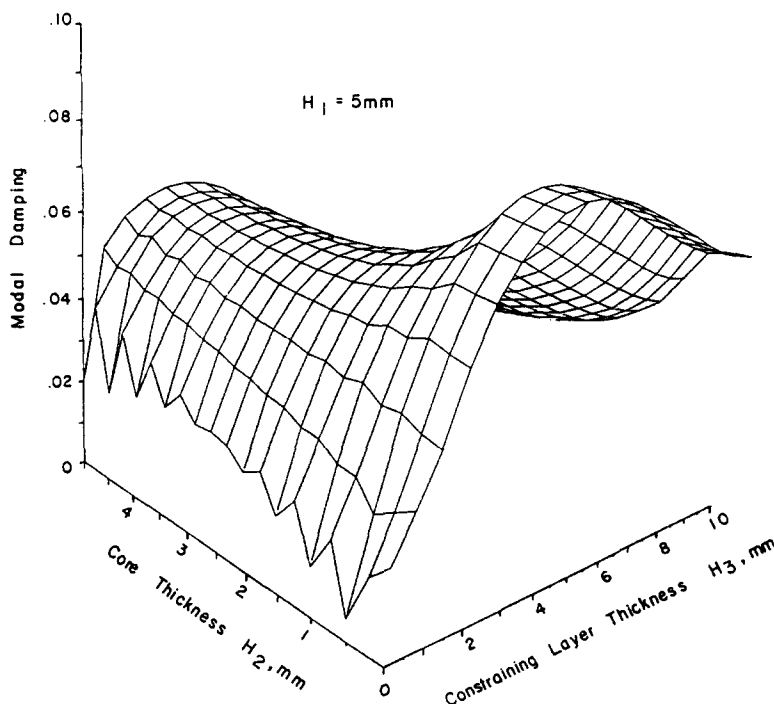

Fig. 5. Variations in modal damping of an unsymmetrical sandwich beam.

method developed by Lifshitz and Leibowitz (1987) for calculating natural frequency and damping of a sandwich beam is considered reliable.

Having established confidence in the method of calculating modal parameters of given sandwich beams, it is worthwhile investigating the dependence of the modal damping on the parameters of the beam structure. In particular, we want to investigate the effects of geometrical changes on the damping. This has practical importance, since constrained damping layers of various thicknesses are available in the market and it is not obvious which one is better for vibration damping in a given structure.

To show variations of damping with thickness of the layers we use two approaches,

- (a) an unsymmetrical beam, in which one layer of the sandwich beam ( $H_1$ ) has a constant thickness and the other two layers vary as shown in Fig. 5, and
- (b) a symmetrical beam, where the two elastic outer layers have the same thickness ( $H_1 = H_3$ ) as shown in Fig. 6.

The first approach depicts a case where a constrained viscoelastic layer is to be bonded to an existing elastic beam, while the second portrays the effects of thicknesses on damping in a specific case of a symmetrical beam. Since Figs 5 and 6 are not intended to be used as design graphs, but merely as an illustration of the problems involved in selecting damping layers, we decided to present them in a dimensional form for specific beams. In this form it is easier to show the effects of geometrical changes on damping. The possibility of normalizing Fig. 5 with respect to the base layer ( $H_1$ ) is discussed later.

The surface in Fig. 5 is similar to a saddle, parallel to the  $H_2$  axis. It shows that for a given thickness of damping layer,  $H_2$ , the symmetrical design ( $H_1 = H_3$ ) gives the highest damping. When the beam is symmetric ( $H_1 = H_3 = 5$  mm), thinner damping layers give higher modal damping than thicker ones, but even the maximum damping falls considerably below the damping of the core material. When the constraining layer is thin ( $H_3 < H_1$ ), as in most commercial cases, we get practically the same modal damping regardless of the core thickness, and the damping value is low.

The surface in Fig. 5 is drawn for a particular family of cantilever beams, where  $H_1 = 5$  mm. Similar surfaces can be drawn for other values of  $H_1$ , but they cannot be reduced to a single surface by a normalization procedure with respect to  $H_1$ . To show this, Fig. 5 is

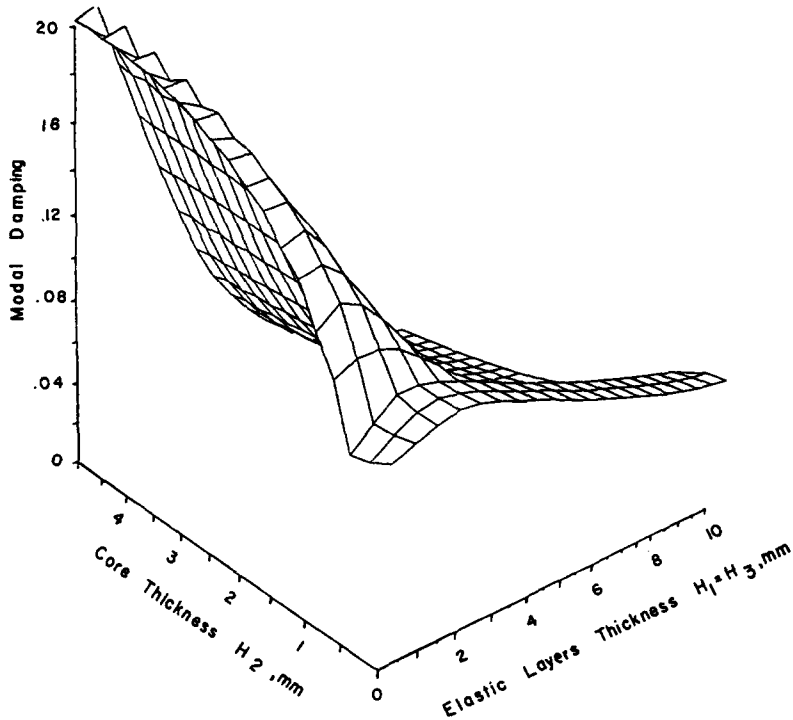

Fig. 6. Variations in modal damping of a symmetrical sandwich beam.

normalized with respect to  $H_1$  (see Fig. 7), and we also include thicknesses beyond the practical range of damping layers. If we repeat the same calculations for a sandwich beam with a base layer of different thickness (say  $H_1 = 2$  mm), the surface (shown in Fig. 8) is different from the one shown in Fig. 7. Thus, for each value of  $H_1$  we get a different surface of damping values. The difference between Fig. 7 and Fig. 8 can be viewed from a different angle, by drawing lines of equal damping as shown in Figs 9 and 10. It becomes clear that beams of the same ratios  $H_3/H_1$  and  $H_2/H_1$  but different values of  $H_1$ , have different values of modal damping.

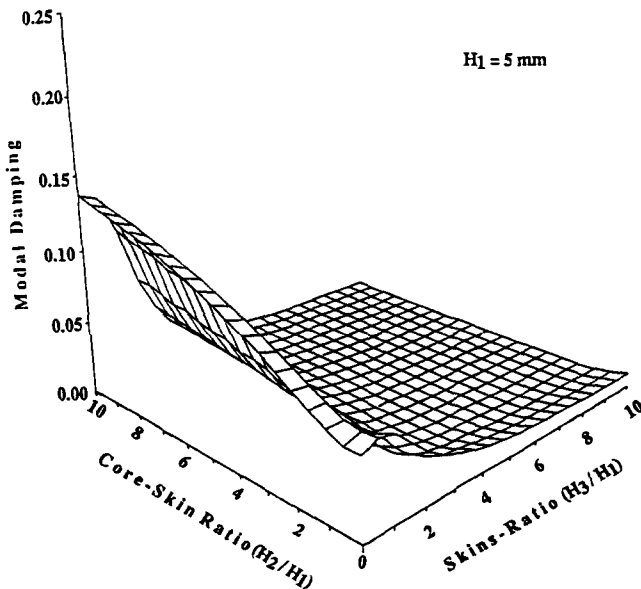

Fig. 7. Variations in modal damping of an unsymmetrical normalized sandwich beam ( $H_1 = 5$  mm).

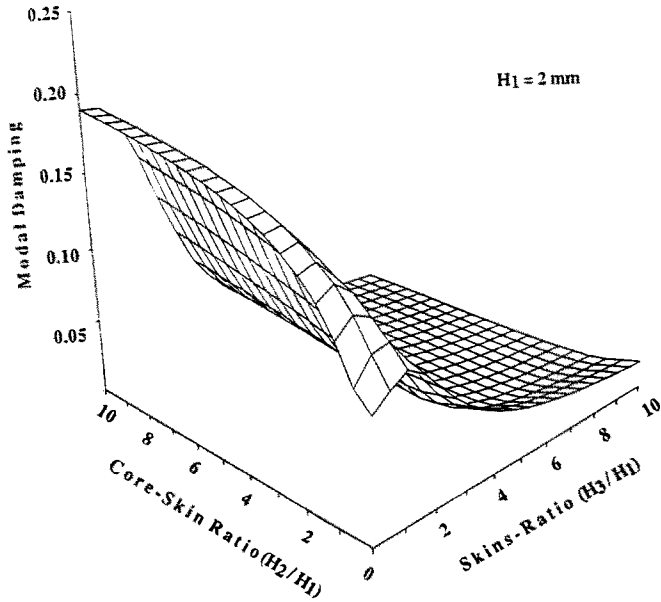

Fig. 8. Variations in modal damping of an unsymmetrical normalized sandwich beam ( $H_1 = 2 \text{ mm}$ ).

The surface in Fig. 6, which represents damping of symmetric sandwich beams, is different. The dependence of modal damping on the core thickness becomes stronger as the elastic layers get thinner. For thin elastic layers the modal damping increases rapidly with core thickness, as can be seen also in Figs 7 and 8, and reaches values close to the damping of the core material. This is expected because a sandwich beam with a thick core and very thin outer skins ceases to function as a sandwich beam.

In practice, however, there are generally design constraints that must be met and we are not free to select the geometry of the sandwich beam at will. This, with the complex

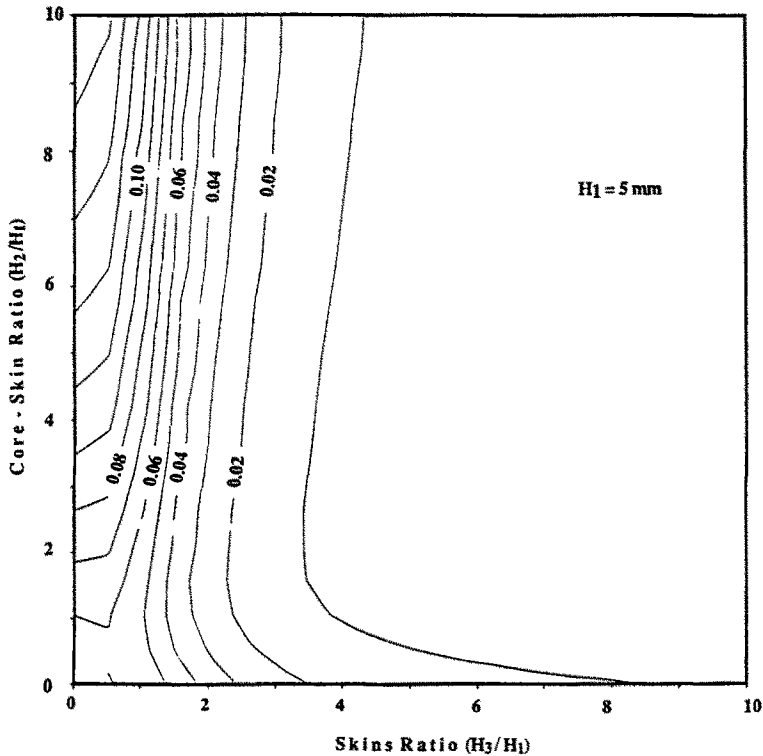

Fig. 9. Lines of equal damping of an unsymmetrical normalized sandwich beam ( $H_1 = 5 \text{ mm}$ ).



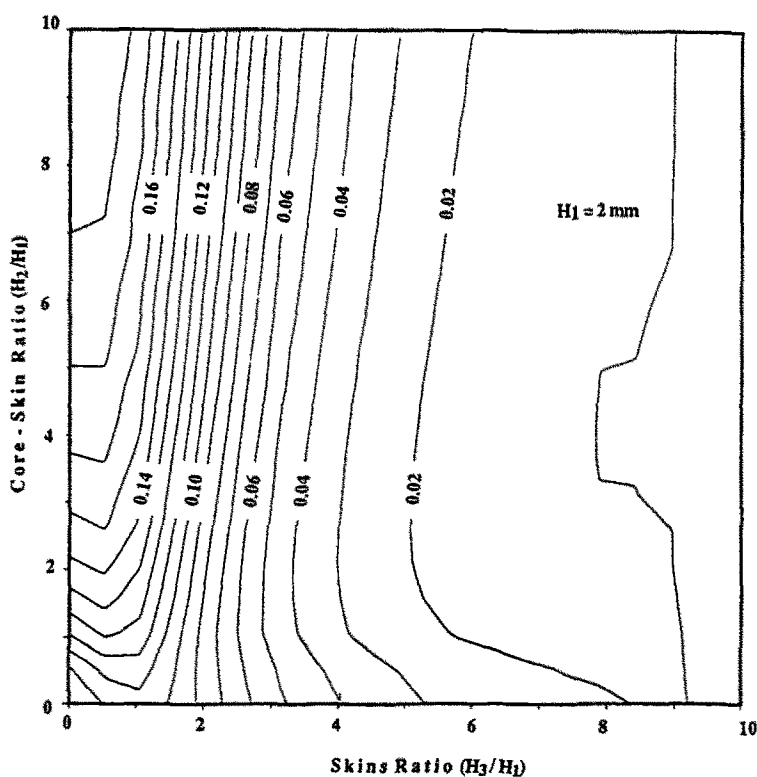

Fig. 10. Lines of equal damping of an unsymmetrical normalized sandwich beam ( $H_1 = 2$  mm).

shape of the damping surfaces have motivated the development of the optimization program (Lifshitz and Leibowitz, 1987) as a design tool for sandwich beams with maximum viscoelastic damping.

#### CONCLUSIONS

- (1) The method of calculating modal parameters for a 3-layer sandwich beam, by a numerical solution of the sixth-order determinant derived from eqs (9) and (10), can be used within the range of engineering accuracy. Values for the first mode of vibrations are within a few per cent of experimental values. The agreement between experimental and calculated values for the second mode is not as good.
- (2) Dependence of modal damping on parameters of the sandwich beam (geometry and materials) is very complex and cannot be predicted by elementary calculations. Under certain conditions (Fig. 5) a thinner core gives higher damping values, whereas under other conditions (Fig. 6) a thicker core leads to higher damping. The recommendation is, therefore, to use an optimization technique like the one developed by Lifshitz and Leibowitz (1987) for solving real design problems.

#### REFERENCES

- CAE International, General Electric, SDRC (1983). Reference Manual for Modal-Plus 8.0.
- Ewin, D. J. (1984). *Modal Testing, Theory and Practice*. John Wiley, New York.
- Formenti, D. and Welaratna, S. (1981). Structural dynamics modification. An extension to modal analysis. SAE Technical Paper Series 811043.
- Hildebrand, F. B. (1956). *Introduction to Numerical Analysis*, Chapter 9. McGraw-Hill, New York.
- Jones, D. I. G. and Parin, M. L. (1972). Technique for measuring damping properties of thin viscoelastic layers. *J. Sound Vibr.* **24**, 201–210.
- Lifshitz, J. M. and Leibowitz, M. (1987). Optimal sandwich beam design for maximum viscoelastic damping. *Int. J. Solid Structures* **23**, 1027–1034.
- Mead, D. J. and Markus, S. (1969). The forced vibrations of a three layered damped sandwich beam with arbitrary boundary conditions. *J. Sound Vibr.* **10**, 163–175.

- Ramsey, K. A. (1975). Effective measurement for structural dynamic testing—Part I. *J. Sound Vibr.* **9**(11), 24–35.
- Ramsey, K. A. (1976). Effective measurement for structural dynamic testing—Part II. *J. Sound Vibr.* **10**(4), 18–31.
- Rao, D. K. (1977). Computer programs for determining exact frequency and loss factors of sandwich beams with arbitrary boundary conditions. Internal Report, Institut für Mechanische Schwingungslehre und Maschinen Dynamik, Technische Universität Berlin, West Germany.
- Smith, G. M., Bierman, R. L. and Zitek, S. J. (1983). Determination of dynamic properties of elastomers over broad frequency range. *Exp. Mech.* **23**, 158–164.
- Van Blancum, M. L. (1978). A review of Prony's method techniques for parameter estimation workshop. Griffiths Air Force Base, 24–26 May, pp. 125–139.